

Thank you for purchasing the SHARP Electronic Cash Register Model XE-A106. Please read this manual carefully before operating your machine. Keep this manual for future reference. It will help you solve any operational problems that you may encounter.

For assistance call
1-800-BE-SHARP

For Easy Set-up,
See "Getting Started"

Maintenance

Batteries

This cash register provides a low battery symbol (L) and a no battery symbol (L) which appears on the far left of the display in one of the following situations:

Low battery symbol (L)

- When the voltage of the batteries installed in the cash register is under the required level.

No battery symbol (L)

- When three batteries are not installed in the cash register.
- When the batteries installed in the cash register are dead.

When either of these symbols appear, check batteries. If no batteries are installed, install three new "AA" batteries at once. If batteries are already installed, replace them with new ones as soon as possible. If the AC power cord is disconnected or a power failure occurs when the batteries are dead or not installed, all the programmed settings will be reset to the default settings and any data stored in memory will be cleared.

NOTE If the low battery symbol appears while making a transaction, complete the transaction before replacing the batteries.

- NOTE** Improper use of batteries could cause them to burst or leak, which might damage the interior of the cash register. Please take the following precautions:
- Be sure that the positive (+) and negative (-) poles of each battery are oriented properly.
 - Never mix batteries of different types.
 - Never mix old batteries and new ones.
 - Never leave dead batteries in the battery compartment.
 - Remove the batteries if you plan not to use the cash register for long periods.
 - Should a battery leak, clean out the battery compartment immediately, taking care not to let the battery fluid come into direct contact with your skin.
 - If an incorrect battery is used, it may explode or leak.
 - For battery disposal, follow the relevant law or regulation in your country.

Replacement

- Be sure the cash register is plugged in.
- Turn the mode switch to the REG position.

3. Pull the printer cover upward and detach it.

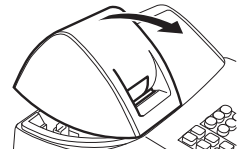

4. Open the battery cover and remove the old batteries.

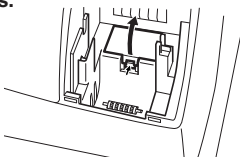

View from rear

5. Install three new "AA" batteries into the battery compartment.

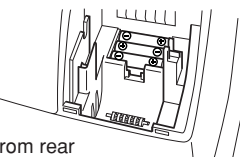

View from rear

6. Check that the "L" symbol has disappeared.

7. Close the battery cover.

8. Replace the printer cover.

NOTE Improper use of batteries could cause them to burst or leak, which might damage the interior of the machine. See the cautions in the "Getting Started" section.

Paper Roll

When colored dye appears on the edges of the paper roll, it is time to replace the roll. Use paper of 2 1/4" (57 mm) in width. To prevent jamming be sure to use paper specified by SHARP.

Replacement (Journal printing)

- Turn the mode switch to the REG position.
- Open the printer cover.
- Press [F] to advance the paper by several lines and then cut the paper to remove the take-up spool from the bearing.

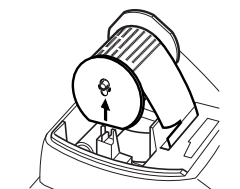

4. After cutting the existing paper, remove the paper roll. Then remove the remaining paper by pressing [F].

5. Remove the paper holding plate from the spool.

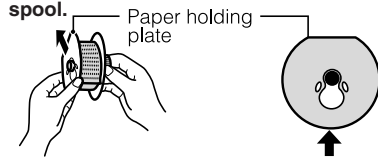

Push this part in the direction of the arrow to remove paper holding plate.

6. Remove the used journal paper roll (if used) from the take-up spool.

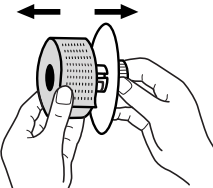

7. Install a new paper roll, the paper holding plate and the take-up spool according to the instructions in "Getting Started."

NOTE In the case of receipt printing, steps 3, 5 and 6 should be omitted and the paper holding plate and the take-up spool need not be installed in step 7.

Replacing the Ink Roller

- Open the printer cover.
- Remove the ink roller by pulling it upward.



3. Install a new ink roller.



4. Close the printer cover.

Drawer Handling

Locking the Drawer

Develop the habit of locking the drawer when not using the register for any extended period of time.

- To lock:** Insert the key into the drawer lock and turn it 90 degrees counter-clockwise.
- To unlock:** Insert the key into the drawer lock and turn it 90 degrees clockwise.

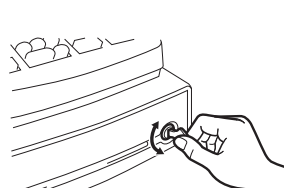

Removing the Drawer

To remove the drawer, pull it out and lift it up.

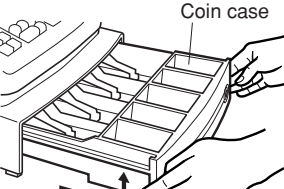

- NOTE**
- To prevent burglary, it is a good idea to empty the drawer after work and leave it open at the end of the day.
 - Coin case is detachable. Also the separators of the coin case are removable.

Manually Opening the Drawer

In case of a power failure or if the machine is out of order, locate the lever at the bottom of the machine and move it in the direction of the arrow to open the drawer. The drawer will not open if it is locked with the drawer lock key.

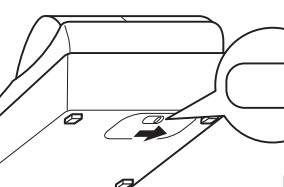

Installing the Mounting Bracket

A mounting bracket which prevents the register from moving accidentally is supplied with your XE-A106 register. Attach the bracket to a table where the register rests, as follows:

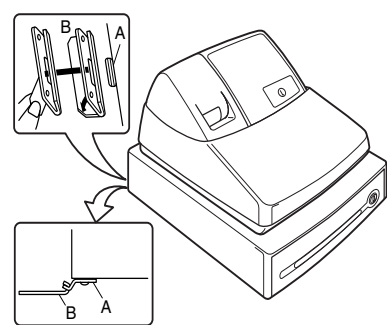

How to attach the mounting bracket

- Thoroughly clean the table surface where you wish to place the bracket (B).
- Peel off the release paper of the adhesive tape on the bracket.
- Hook the bracket onto the hook (A) at the bottom of the back of the register.
- Hold down the bracket so that it firmly sticks to the table surface.

How to release the register from the mounting bracket

Lift up the front of the register and pull it towards you.

Before Calling for Service

If you encounter any of the following problems, please read below before calling for service.

The display shows symbols that do not make sense.

- Has the machine been initialized properly as shown in "Getting Started"?

The display will not illuminate while the machine is turned on. The machine will not operate when any key is pressed.

- Is the power supplied to the electrical outlet? (Plug another electrical device into the outlet for confirmation.)
- Is the power cord firmly connected to the electrical outlet?

Specifications

Model:

XE-A106

Size:

Inches: 13.0 (W) x 14.3 (D) x 9.21 (H)

Millimeters: 330 (W) x 363 (D) x 234 (H)

Weight:

Approx. 11.0 lbs. (5.0 kg)

Power Source:

120V AC±10%, 60Hz

Power Consumption:

Stand-by: 4 W, Operating: 12.5 W

Working Temperature:

32 to 104°F (0 to 40°C)

Display:

LED (Light-Emitting Diode) numeric display

Printer:

1 station, print wheel selective type

Printing Capacity:

Max. 13 characters

Paper Roll:

Width: 2 1/4" ± 1/64" (57.5mm ± 0.5mm)

Max. external diameter: 3-5/32" (80mm)

Min. internal diameter: 15/32" (12mm)

Cash Drawer:

4 slots for bills, 5 for coins

Accessories (supplied):

- Paper roll: 1 roll
- Mode key: 1
- Drawer lock key: 1
- Instruction manual (English): 1 copy
- Instruction manual (Spanish): 1 copy
- Quick Start Guide (English): 1 copy
- Quick Start Guide (Spanish): 1 copy
- Ink roller: 1 (installed)
- Take-up spool: 1
- Paper holding plate: 1
- Mounting bracket: 1
- Specifications and appearance are subject to change without notice for improvement.

The display is illuminated, but the machine will not accept key entries.

- Is the mode switch properly set to the REG position?
- Has the machine been initialized properly as shown in "Getting Started"?

Journal paper will not feed properly in the printer.

- Is the take-up spool installed properly?
- Is there a paper jam?
- Is the journal format selected in the printing format programming? (If the receipt format is selected, the paper is not wound around the take-up spool.)

Printing is faded or illegible.

- Is the ink roller used up?
- Has the ink roller been installed properly?

END-USER LIMITED WARRANTY

SHARP ELECTRONICS CORPORATION warrants to the first end-user purchaser (the "Purchaser") that this Sharp brand product (the "Product"), when new and shipped in its original container, will be free from defective workmanship and materials, and agrees that it will, at its option, either repair the defect or replace the defective Product or part thereof with a new or remanufactured equivalent at no charge to the Purchaser for parts or labor for the period(s) set forth below.

This warranty does not apply to any appearance items of the Product nor to the additional excluded item(s) set forth below nor to any Product the exterior of which has been damaged or defaced, which has been subjected to improper voltage or other misuse, abnormal service or handling, or which has been altered or modified in design or construction.

In order to enforce the rights under this limited warranty, the Purchaser should follow the steps set forth below and provide proof of purchase to the servicer.

To the extent permitted by applicable state law, the warranties set forth herein are in lieu of, and exclusive of, all other warranties, express or implied. Specifically, ALL OTHER WARRANTIES OTHER THAN THOSE SET FORTH ABOVE ARE EXCLUDED. ALL EXPRESS AND IMPLIED WARRANTIES INCLUDING THE WARRANTIES OF MERCHANTABILITY, FITNESS FOR USE, AND FITNESS FOR A PARTICULAR PURPOSE ARE SPECIFICALLY EXCLUDED. If, under applicable warranties is limited to the period(s) from the date of purchase set forth below.

Neither the sales personnel of the seller nor any other person is authorized to make any warranties other than those described herein, or to extend the duration of any warranties beyond the time period described herein on behalf of Sharp.

The warranties described herein shall be the sole and exclusive warranties granted by Sharp and shall be the sole and exclusive remedy available to the Purchaser. Correction of defects, in the manner and for the period of time described herein, shall constitute complete fulfillment of all liabilities and responsibilities of Sharp to the Purchaser with respect to the Product, and shall constitute full satisfaction of all claims, whether based on contract, negligence, strict liability or otherwise. In no event shall Sharp be liable, or in any way responsible, for any damages or defects in the Product which were caused by repairs or attempted repairs performed by anyone other than an authorized servicer. Nor shall Sharp be liable or in any way responsible for any incidental or consequential economic or property damage. Some states do not allow limits on warranties or on remedies for breach in certain transactions; in such states, the limits herein may not apply.

Model Specific Section (Carry-in Service)

Your Product Model Number & Description:

XE-A106 Cash Register
(Be sure to have this information available when you need service for your product.)

Warranty Period for this Product:

One (1) Year Parts and 90 Days labor from date of purchase

Additional Item(s) Excluded from Warranty Coverage (if any):

Any consumable items such as paper supplied with the Product.

Where to Obtain Service:

From a Sharp Authorized Servicer located in the United States. Call the location of the nearest Sharp Authorized Servicer, call Sharp toll free at 1-800-BE-SHARP.

What to do to Obtain Service:

Ship prepaid or carry in your Product to a Sharp Authorized Servicer. Be sure to have **Proof of Purchase** available. If you ship the Product, be sure it is insured and packaged securely.

TO OBTAIN PRODUCT INFORMATION, CALL 1-800-BE-SHARP OR VISIT www.sharpsusa.com.

SHARP
SHARP ELECTRONICS CORPORATION
Sharp Plaza, Mahwah, New Jersey 07495-1163
1-800-BE-SHARP
<http://www.sharpsusa.com>

Getting Started

Initializing the Cash Register

For your cash register to operate properly, you must initialize it before programming for the first time. Follow this procedure.

- Remove the register from its packing carton.
- Insert the supplied mode key into the mode switch and turn it to the REG position.
- Insert the plug into the AC outlet.
IMPORTANT: This operation must be performed without batteries loaded.
- The buzzer will sound three times. Now your cash register has been initialized. The display will show "0.00" with "L".

Installing Batteries

Batteries must be installed in the cash register to prevent data and programmed contents from being lost from the memory in case of accidental disconnection of the AC cord or power failure. Please install three new "AA" batteries before programming and operating the cash register. Once installed, the batteries will last approximately one year. When it is time to replace them, the "L" symbol will appear on the display to indicate a low battery voltage. If the symbol appears, you must replace them within two days.

Install the batteries according to this procedure with the AC cord connected:

- Push the printer cover forward and detach it.

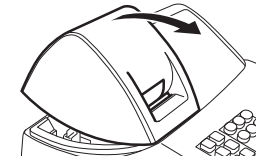

2. Open the battery cover next to the paper roll cradle.

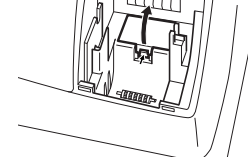

View from rear

3. Insert three new AA batteries.

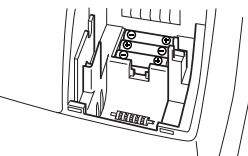

View from rear

4. When the batteries are properly installed, "L" on the display will disappear. Close the battery cover.

5. Attach the printer cover.

Installing a Paper Roll

Always install the paper roll even when you set the register for not printing journal or receipt in REG mode.

- Push the printer cover forward and detach it.
- Place a paper roll in the paper roll cradle so that the paper unrolls from the bottom.

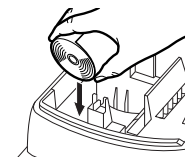

NOTE Before placing a new paper roll in the paper roll cradle, cut off the pasted (taped) part of the paper and confirm that the cut end of the paper is straight.



- Insert the paper straight into the paper inlet, and press the [F] key. The inserted end comes out at the printing area.

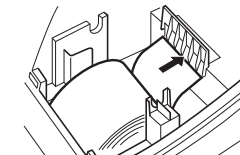

4. (For journal printing)

- Insert the top end of the paper into the slit in the take-up spool shaft and fold the inserted end toward you.
- Wind the paper two or three turns.
- Mount the paper holding plate onto the take-up spool.

Put the spool shaft in the larger hole of the paper holding plate and push the plate in the direction of the arrow.

- Place the take-up spool on the bearing.



5. Attach the printer cover. (For receipt printing, step 4 should be omitted.)

WARNING

FCC Regulations state that any unauthorized changes or modifications to this equipment not expressly approved by the manufacturer could void the user's authority to operate this equipment. **Note:** This equipment has been tested and found to comply with the limits for a Class A digital device, pursuant to Part 15 of the FCC Rules. These limits are designed to provide reasonable protection against harmful interference when the equipment is operated in a commercial environment. This equipment generates, uses, and can radiate radio frequency energy and, if not installed and used in accordance with the instruction manual, may cause harmful interference to radio communications. Operation of this equipment in a residential area is likely to cause harmful interference in which case the user will be required to correct the interference at his own expense.

CAUTION

The socket-outlet shall be installed near the equipment and shall be easily accessible.

FOR YOUR RECORDS

Please record below the model number and serial number, for easy reference, in case of loss or theft. These numbers are located on the right side of the unit. Space is provided for further pertinent data.

Model Number _____

Serial Number _____

Date of Purchase _____

Place of Purchase _____

Handling Cautions

Install the cash register in a location not subject to direct sunlight, unusual temperature changes, high humidity, or splashing water.

Do not operate the cash register with wet hands. Water can cause internal component failure.

The cash register plugs into any standard wall outlet (120V AC ± 10%). Avoid connecting any other electrical devices on the same electrical circuit since such connection could cause the cash register to malfunction.

When cleaning the cash register, use a dry, soft cloth. Never use volatile liquids, such as benzene or thinner. Chemicals can discolor or damage the cabinet.

For protection against data loss, please install three new "AA" batteries before using the cash register. However, never forget you must initialize the cash register before installation of batteries; otherwise damage to memory contents or malfunctioning of the register will occur. You can start operating it only after initializing it and then installing batteries.

For complete electrical disconnection, pull out the main plug.

Setting the Time

Turn the mode switch to the Z/PGM position and enter the time in 4 digits ("hhmm" format) using the 24 hour system. Press the [M] key once to continue programming or twice to exit the program mode.

[M] [4] [3] [0] [0] [M] [M]

Time (2:30 p.m.)

NOTE Always enter the time in 4 digits even when the hour is in the single digit. For example,

enter [M] [2] [3] [0] [0] for 6:30 a.m.

• 6:30 a.m. prints as "06-30" and 6:30 p.m.

prints as "06-30@".

Setting the Date

In the Z/PGM mode, enter the date in 6 digits using the month-day-year format. Press the [M] key once to continue programming or twice to exit the program mode.

[M] [0] [2] [1] [5] [0] [0] [M] [M]

Date (February 15, 2010)

NOTE Always enter the date in 6 digits. For

example, enter [M] [0] [2] [0] [3] [0] [0] for

February 15, 2010. If you change the date

format in the Z/PGM mode, follow the newly

specified format when setting the date.

Checking the Time and Date

You can display the time and date to check if they are correctly set.

- Turn the mode switch in the REG position.
- Press the [M] key once to display the time.
- Press the [M] key a second time to display the date.

Programming the Tax Rate

Before you can proceed with registration of sales, you must first program the tax that is levied in accordance with the law of your state. Your cash register comes with the ability to program four different tax rates. In most states, you will only need to program Tax 1. However, if you live in an area that has a separate local tax (such as a Parish tax) or a hospitality tax, your register can be programmed to calculate these separate taxes.

In order to program the tax to be collected in accordance with the law of your state, you must specify the tax rate(s) and minimum taxable amount(s).

When you program the tax status for a department, tax will be automatically added to sales of items assigned to the department according to the programmed tax status for the department. You can also enter tax manually.

There are two tax programming methods. The tax rate method uses a straight percentage rate per dollar. The tax table method requires tax break information from your state or local tax offices. Use the method which is acceptable in your state. You can obtain necessary data for tax programming from your local tax office.

Entries

Operation Examples

When Paid by Cash

- Turn the mode switch to the REG position.
- Enter the clerk code (1 to 4) and press [CL]. (Once the clerk code is entered, you need not enter the clerk code at the start of each transaction until the clerk is changed.)
- Enter the price for the first item.
- Press the appropriate department key.
- Repeat steps 2 and 3 for all the remaining items.
- Press [TAX] to display the amount due including any tax (you can omit this step).
- Enter the amount received from the customer (you can omit this step if the amount tendered is the same as the subtotal).
- Press [CAVATNS], and the change due is displayed and the drawer opens.
- Close the drawer.

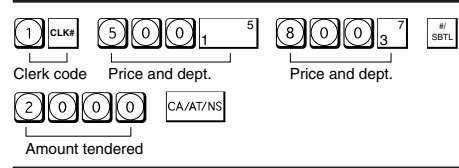

When Paid by a Credit Card

Press [CC] at the end of the transaction. The amount tendered cannot be entered.

When Paid by Check

Press [CHK] at the end of the transaction. The amount tendered can be entered like a cash sale and the change due is displayed.

Mixed Tender Sale

When the amount tendered by cash or check is less than the sales amount including tax, the display shows a deficit and "C". To compensate for the deficit, make an additional amount-tendered entry or make a charge entry.

Department

Repetitive Department Entries

To enter two or more of the same item, press the appropriate department key repeatedly.

Multiplication Entries

To enter a sale of two or more of the same item, use [MUL] key for multiplication.
Example: Selling five pieces of \$1.50 item (department 1) and three pieces of \$3.50 item (department 3) for check payment.

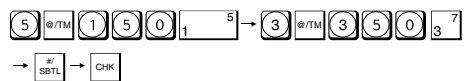

Single Item Cash Sale (SICS) Entry

This function is used for the sale of one item to be paid by cash. It is applicable only to departments programmed for single-item cash sales or to PLUs associated with such departments. After the appropriate department or [MUL] key is pressed, the transaction is complete and the drawer opens. For the programming of SICS, see the Department Status section in "Programming."

PLU (Price Look Up)

The PLU function allows speedy key entries. When a PLU code has been assigned to an item and a price for it has been programmed, entry of the code automatically calls up the price for the item. Up to 80 PLU codes are programmable. See the PLU programming section in "Programming"

To enter a sale of a PLU item, simply enter its code and press [MUL].

Tax Calculation

Automatic Tax Calculation

When the register is programmed with a tax table or rate method and the tax status of a department is programmed as taxable, the register automatically computes the tax on any item entered using the department key for that department or a PLU code associated with that department.

Taxable Subtotal

You can display the taxable 1 or taxable 2 subtotal by pressing either tax shift key and then [MUL]. The subtotal of taxable 1 or taxable 2 entries is displayed. You cannot display the subtotal of taxable 3 or 4 items.

Tax Shift

You can change the programmed taxable 1 or 2 status of each department key by pressing one or both of the two tax shift keys [TAX1] and [TAX2]. To change the taxable status, press the appropriate tax shift key just before the department, [MUL] or [S] key. In case of repetitive entries, the shifted tax status is used.

Tax Delete

This function is used when the taxable item or items once entered need to be made non-taxable. Press [TAX1] or [TAX2], then [MUL], and [MUL] and all entries made so far in the transaction for items with the specified taxable status will be made non-taxable.

To make all entries up to that point non-taxable, press [TAX1] and [TAX2], then [MUL], and [MUL]. Subsequent entries in the transaction remain unaffected and will be taxed normally.

Manual Tax

You can apply tax manually when the automatic tax calculation function cannot be used. Each manual tax entry (for Tax 1 or Tax 2) can be made only once during a transaction. After a manual tax entry, you cannot make any further item entries.

Manual tax 1 entry:

[MUL] and [MUL] → tax amount → [MUL]

Manual tax 2 entry:

[MUL] and [MUL] → tax amount → [MUL]

Opening the Drawer with No Sale

Just press [CAVATNS] and the drawer opens.

Percent Key

The percent key is used to apply a discount or premium to an item or to a subtotal. You can manually enter a discount (or premium) rate. Once the rate is preset for [MUL], you can skip the step of entering the rate.

Discount for an item:

entry of an item → percentage rate → [MUL]
(ex. For 20%, enter [2] [0] [0] [0].)

Discount for a subtotal:

entry of all items → [MUL] → percentage rate → [MUL]
(ex. For 5%, enter [5] [0] [0].)

Entering a Refund

The cash register has no refund key. You must use the following alternative method to make a refund entry: A negative department for refund must be programmed in advance. Check the taxable status of the returned item is the same as that of the programmed negative department. If not, use the appropriate tax shift key to change the taxable status.

Procedure

unit price of the returned item → negative dept. key → [CAVATNS] or [CH]

Non-add Code Number

Non-add code numbers can be entered and printed on the journal (or receipt) during the entry of a sale. Non-add codes can be used for credit numbers, check numbers, serial numbers, product codes, service charge codes or any other numbers for reference to specific

transactions. Non-add code numbers can be entered in the REG or VOID mode.

Non-add code number entry procedure:
a code number of up to 8 digits → [MUL]

Received-on-Account and Paid-Out Entries

The received-on-account (RA) entry function is used for entering the cash received not directly connected with a sale. The paid-out (PO) entry function is used for recording the money taken from the drawer for payment not directly connected with a sale. These functions are available in the X/Flash mode.

Received-on-account entry (X/Flash mode):
amount received (up to \$799999.99) → [MUL]

Paid-out entry (X/Flash mode):
amount paid out (up to \$799999.99) → [MUL]

When an Error Occurs

When your register goes into an error mode, it will display the error symbol "E" accompanied with a warning beep. Clear the error state by pressing the [MUL] key and take the appropriate action.

1. **You enter a number of more than 7 digits for the department price or a number larger than the 79999999 (8 digits) for other amounts.**

Press [MUL] and re-enter a correct number.

2. **You make an error in key operation:**

Press [MUL] and operate keys correctly.

3. **You make an entry beyond a programmed entry digit limit:**

Press [MUL] and check if the entered amount is correct. If not correct, re-enter a correct number. If correct, check the setting of the entry digit limit.

4. **A subtotal exceeds 79999999 (eight digits):**

Press [MUL] and then press [CAVATNS], [CH] or [MUL] to finish the transaction.

5. **The number of an item exceeds 3 digits in multiplication entry:**

Press [MUL] and re-enter the correct number.

Error Escape Function

When an error or something uncontrollable occurs during a transaction entry and you cannot keep the customer waiting, press [MUL] twice (following [MUL] when in the error state). You can escape the situation and finalize the transaction as a cash sale at that time. Transaction entries to that point are registered.

Programming

Before you begin programming, turn the mode switch to the Z/PGM position.



Follow these steps as needed.

NOTE If you do not press the [MUL] key at the end of each programming step, you can continue programming without printing the programming report.

Programming by Departments

Preset Unit Price

The preset unit price function assigns a frequently purchased item to a department key and enables you to enter the price simply by pressing the department key. Specify a price using the following sequence:

Unit Price (Max. 5 digits) → Dept. key (→ [MUL])

Department Status

You can specify various status parameters (+/- sign, single item cash sale function, taxable status and entry digit limit) for a department key. Use the following sequence:

ABCDEFGH → [MUL] → Dept. key (→ [MUL])

where A to G represent the following choices.

A: Choice of + or - sign

Enter 0 for + or 1 for -.

B: Choice of single item cash sale (SICS) function

Enter 0 for normal or 1 for single item cash sale.

C, D, E and F: Choice of taxable status

Enter 0000 for non-taxable, 0001 for taxable 1, 0010 for taxable 2, 0100 for taxable 3, 1000 for taxable 4 or 0011 for taxable 1 and 2.

G: Entry digit limit (0 to 7 digits)

Enter 0, 1, 2, 3, 4, 5, 6 or 7

PLU (Price Look-Up) Programming

Each PLU is associated to a department and the programmed contents for the department are automatically applied. Your cash register is pre-programmed so PLU codes 1-10 are assigned to department 1 and PLU codes 11-80 are disabled. To set the price or change the associated department, use the following sequence:

PLU code → [MUL] → Price → Dept. key (→ [MUL])

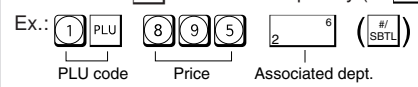

To disable a PLU code, use the following sequence:

PLU code → [MUL] → [VOID] (→ [MUL])

Tax Programming

Tax Table Programming

If you are in an area that uses a tax table for tax calculation, you can program the cash register accordingly. Tax table programming can be performed for Tax 1 and Tax 2.

Sample tax table 1 (6%):

Tax	Breakpoint	Breakpoint difference	
.00	.01	.10	Non-cyclic
.01	.11	.12	Cyclic I
.02	.23	.16	
.03	.39	.18	
.04	.57	.16	
.05	.73	.16	
.06	.89	.22	
.07	1.11	.12	Cyclic II
.08	1.23	.16	
.09	1.39	.18	
.10	1.57	.16	
.11	1.73	.16	
.12	1.89	.22	
.13	2.11		

Sample tax table 2:

Tax	Breakpoint
.00	.01
.01	.11
.02	.26
.03	.47
.04	.68
.06	.89
.09	1.11
.10	1.26
.11	1.47
.12	1.68
.14	1.89
.17	2.11

NOTE

If tax is not shown for every cent, use the breakpoint of the next highest tax amount for each missing breakpoint. In sample tax table 2, tax is not shown for .05, .07, .08, .13, .15 and .16. Likewise, the corresponding breakpoints are not shown. To complete the table, simply insert the next highest breakpoint after each missing figure. Therefore, the breakpoint for .05 would be .89, .07 and .08 would be 1.11, etc.

Use the following sequence for tax programming:

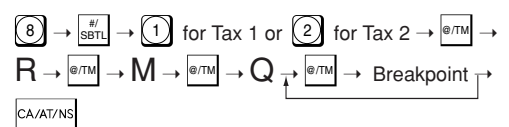

where R, M and Q represent the following:

R: Tax rate (0.0000% to 99.9999%) x 10000

If the rate is fractional, it should be converted to its decimal equivalent before entering.

M: Cycle (0.01 to 99.99) x 100

In tax table 1, you can see that the breakpoint differences repeat in cycle. The value of M may be viewed as the taxable amount which is covered by a cycle. Thus, it can be determined by adding all of the breakpoint differences in a cycle or by simply taking the difference between the first breakpoint of the cycle and the first breakpoint of the next cycle.

Q: Minimum taxable amount (0.01 to 99.99) x 100
This represents the smallest amount for which tax must be collected. In some states, sales whose amounts are less than a specific minimum taxable amount are not subject to taxation.

Breakpoints (0.01 to 99.99) x 100

The tax amount increases in stages. The value of a taxable subtotal at which the tax amount changes is called a breakpoint. The difference between one breakpoint and the next is called the breakpoint difference. A group of breakpoint differences is repeated at regular intervals and each of these intervals is called a cycle. A maximum of 18 breakpoints (for tax types 1 and 2), between 0.01 to 99.99, can be programmed. Intervals between breakpoints must be less than one dollar.

Example: Programming Tax 1 as 6% sales tax using sample tax table 1.

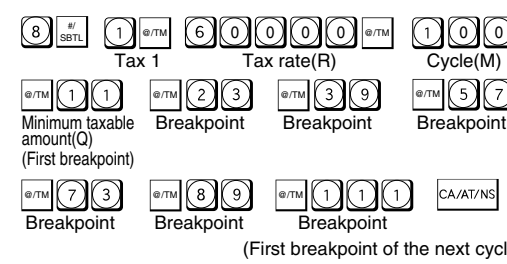

Programming the Percent Key

Percent Key Function

The [MUL] key can be programmed as a discount key or as a premium key. The taxable status of the [MUL] key can also be programmed though it is pre-programmed as a non-taxable discount key. Use the following sequence:

ABCDE → [MUL] → [MUL] (→ [MUL])

where A to E represent the following choices

A: Choice of + or - sign

Enter 0 for + or 1 for -.

B, C, D and E: Choice of taxable status

Enter 0000 for non-taxable, 0001 for taxable 1, 0010 for taxable 2, 0100 for taxable 3, 1000 for taxable 4 or 0011 for taxable 1 and 2.

Initial setting: - (discount), non-taxable ("10000")

Programming the percent rate

Use the following sequence:

Percent rate (0.01% to 99.99%) → [MUL] (→ [MUL])

(ex. For 10.00% enter [1] [0] [0] [0].)

Printing Format

You can choose either a journal or receipt format and specify other options for the printing format. Use the following sequence:

[MUL] → [MUL] → ABCDEFG → [MUL] (→ [MUL])

A: Printing journal/receipt in the REG mode

Enter 0 for printing or 1 for no printing.

B: Journal or receipt format

Enter 0 for journal format or 1 for receipt format. (In the receipt format, the paper is fed by a few lines upon finalization of each transaction. In the journal format, the paper is wound around the take-up spool.)

C: Printing date

Enter 0 to print or 1 not to print

D: Printing time

Enter 0 to print or 1 not to print

E: Printing consecutive numbers

Enter 0 to print or 1 not to print

F: Printing taxable subtotal

Enter 0 to print or 1 not to print

G: Printing merchandise subtotal with [MUL]

Enter 0 to print or 1 not to print

Initial setting: printing in the REG mode, journal format, printing date, time and consecutive number, and not printing taxable subtotal and merchandise subtotal ("0000011")

Consecutive Receipt Number

Consecutive receipt number can be printed on every transaction or receipt and report with the date and time. Use the following sequence to set the receipt start number. To start from a specific number, enter the number less one (e.g. if you want to start from receipt number 1001, enter 1000).

Consecutive (receipt) number → [MUL] → [MUL] (→ [MUL])

Initial setting: starting from 0001("0000")

(For miscellaneous settings, secret code and checking machine settings, see the columns below.)

Part Names and Functions

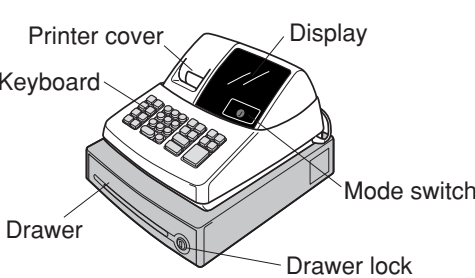

Display

The XE-A106 is equipped with a front LED (Light-Emitting Diode) display that affords easy visibility during transactions.

Symbols and figures appearing on the display:

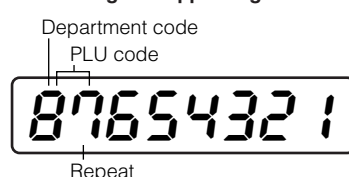

Departments/PLU Code: The department code or PLU code entered appears on the left. For example, if the key for department 1 is pressed, "1" would appear in the extreme left position.

Repeat: Indicates the number of times the same department key is pressed. If an entry is repeated more than ten times, only the first digit is displayed (12 displays as "2").

(E) Error: This symbol appears, accompanied by a warning beep, when an error is made. If this occurs during a transaction because of an excessive digit entry, simply press [MUL] and re-enter correctly.

(P) Program: This symbol remains on the display when the cash register is being programmed in the Z/PGM mode.

(F) Finalization: This symbol appears when a transaction is finalized by pressing [CAVATNS], [CH] or [MUL].

(S) Subtotal: This symbol appears when [MUL] is pressed and the cash register computes the subtotal, and also when the amount tendered is less than the total sale amount.

(Z) Change: This symbol appears whenever the change due amount is displayed.

(L) Low battery: This symbol appears when the power of the installed batteries is below a certain level or you need to replace the batteries with new ones. (see the "Maintenance" section for explanation.)

(B) No battery: This symbol appears when no batteries are installed. (see "Maintenance" and "Getting Started" sections for explanation.)

In addition, the following appear when appropriate:
• The minus sign (-) can appear in positions 2 to 8.
• The decimal point appears in positions 1 to 3.
• When entry of the secret code is necessary, "----" appears in positions 1 to 4.

Reading and Resetting of Sales

X Reports

This report, when taken in the X/Flash mode, prints the accumulated information of sales. Taking an X report is a good way to do a mid-day check on daily sales. You can take X reports any number of times, because they do not affect the cash register's memory.

To issue an X report, turn the mode switch to the X/Flash position and press [CAVATNS].

Z Reports

The contents of Z reports are the same as those of X reports, but issuance of a Z report resets all the transaction totals to zero. To issue a Z report, turn the mode switch to the Z/PGM position.

NOTE If the secret code is programmed, you must enter the secret code and press [CAVATNS] after this step.

For Z reports without grand total resetting

Press [CAVATNS].
NOTE If the secret code is programmed, you have to enter the secret code and press [CAVATNS] again after this step.

For Z reports with grand total resetting

If you want to reset the grand total(GT) when taking the Z report, press [MUL] instead of [CAVATNS]. Other than resetting the grand total, this report is the same as the normal Z reports.

NOTE If the secret code is programmed, you have to enter the secret code and press [MUL] again after this step.

Flash Reports (displayed but not printed)

Press the following key in the X/Flash mode:
Department Total [MUL] Department key
Sales Total